



**C A S S I N I** <sup>TM</sup>

**MODEL: C-872EFS  
800<sub>MM</sub> X 72<sub>MM</sub>**

**REFRACTOR TELESCOPE  
W/ WIRELESS REMOTE  
STABILIZING FOCUS**



**COSMO BRANDS INC.  
WWW.COSMOSOPTICS.COM**



# CASSINI C-872EFS OPERATING INSTRUCTIONS

## INTRODUCTION

THIS TELESCOPE HAS BEEN CORRECTED AGAINST CHROMATIC ABERRATION AND PRODUCED TO PRECISE SPECIFICATIONS.

PRIOR TO USING YOUR NEW CASSINI TELESCOPE, PLEASE READ THE FOLLOWING SETUP AND USAGE INSTRUCTIONS. IT IS IMPORTANT TO PROPERLY ASSEMBLE YOUR TELESCOPE IN ORDER TO ALLOW IT TO FUNCTION PROPERLY.

CONSIDER USING THE TELESCOPE FOR EARTH (TERRESTRIAL) VIEWING BEFORE ATTEMPTING TO VIEW ASTRONOMICAL OBJECTS. THIS WILL FAMILIARIZE YOU WITH HOW POWERFUL EACH EYEPIECE WILL BE, AS WELL AS INTRODUCING YOU TO THE FUNCTIONS OF YOUR ACCESSORY LENSES.

DUE TO THE ERECT IMAGE PRISM POSITIONED IN THE FOCUS HOUSING, THE IMAGE YOU SEE WILL ALWAYS BE RIGHT SIDE UP. AND CORRECTED FROM LEFT TO RIGHT.

WE RECOMMEND YOU BEGIN WITH THE LOWEST POWER EYEPIECE (25MM). WHEN USING THE HIGHEST POWER EYEPIECE (10MM), YOUR POWER WILL BE HIGHER, BUT THE IMAGE WILL APPEAR DARKER; THIS IS DUE TO THE BASIC PHYSICAL PROPERTIES OF THE TELESCOPE. THE HIGHER THE POWER YOU USE THE DARKER THE IMAGE WILL APPEAR AND YOUR VIEWING FIELD WILL BE MORE NARROW.

PLEASE BE PATIENT WHEN USING YOUR TELESCOPE. IT IS A VERY SENSITIVE INSTRUMENT THAT IS CAPABLE OF USING HIGH POWERS. HOWEVER, THE MORE POWER YOU USE, THE MORE SENSITIVE THE TELESCOPE BECOMES. AS A RESULT, THE SLIGHTEST MOVEMENT OF THE TELESCOPE COULD CAUSE YOU TO LOSE THE IMAGE YOU HAVE IN YOUR EYEPIECE. PRACTICE WILL ENABLE YOU TO KNOW HOW MUCH MOVEMENT TO EXPECT WITH EACH EYEPIECE AND IT'S CORRESPONDING POWER.

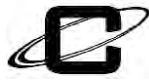

## GETTING THE MOST FROM YOUR TELESCOPE

TAKE THE TIME TO BECOME FAMILIAR WITH YOUR NEW TELESCOPE. LEARN THE NAMES OF THE VARIOUS PARTS, WHERE THEY ARE LOCATED AND THEIR FUNCTION. IT IS THE BEST TO PERFORM THESE FUNCTIONS DURING THE DAY TIME.

WHEN SETTING UP FOR A VIEWING SESSION, PLACE THE TELESCOPE IN AN AREA SHELTERED FROM THE WIND IF POSSIBLE. THE BEST NIGHT TIME VIEWING WILL BE AWAY FROM CITY LIGHT AND WHEN THE ATMOSPHERE IS "STEADY".

WITH A LITTLE PRACTICE YOU WILL LEARN TO JUDGE WHEN VIEWING CONDITIONS ARE GOOD. LOOK FOR THE NIGHTS WHEN THE STARS SHINE BRIGHTLY WITH LITTLE OR NO TWINKLING.

USE LOW POWER TO TAKE ADVANTAGE OF THE WIDER FIELD OF VIEW AND BRIGHTER IMAGE. RESERVE YOUR HIGH POWERS FOR THE NIGHTS WHEN THE VIEWING CONDITIONS ALLOW FOR DETAILED OBSERVATIONS.



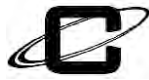

## ACCESSORIES

A. FULLY ADJUSTABLE ALUMINUM TRIPOD

B. EYEPIECES.

25MM = 32X LOWEST POWER/BRIGHTEST IMAGE

10MM PLÖSSL = 80X HIGHER POWER/LESS BRIGHTEST



C. 3X BARLOW.

USED TO INCREASE THE POWER OF ANY GIVEN EYEPIECE BY 300%. FOR EXAMPLE THE 25MM IS 32X POWER AND WITH THE 3X BARLOW IT IS 96X POWER



D. ERECT IMAGE PRISM.

ALLOWS FOR AN OPTICALLY CORRECT UPRIGHT IMAGE THROUGH YOUR TELESCOPE AT ALL TIMES.



E. ELECTRONIC MARS-EYE FINDER

ALLOWS FOR EASY SPOTTING OF OBJECTS.



F. CASSINI CD-ROM  
PLANETARIUM

FROM ANY LOCATION YOU CAN SEE THE SKY AS IT APPEARS AT ANY TIME OF DAY, OR EVEN IN THE FUTURE.



G. ELECTRONIC FOCUSER:

IMAGE STABILIZING ELECTRONIC FOCUSER WITH HELICAL RACK & PINION FOCUSING. ALLOWS FOR PRECISE FOCUSING.



INCLUDES: WIRELESS HANDBOX



NOTE: SPECIFICATIONS ARE SUBJECT TO CHANGE WITHOUT NOTICE.

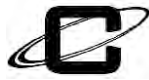

# CASSINI C-872EFS ASSEMBLY INSTRUCTIONS

1. REMOVE PRE-ASSEMBLED TRIPOD

2. ADJUST TRIPOD TO PROPER HEIGHT BY LOOSENING, ADJUSTING AND TIGHTENING THE LOCKING KNOBS.



3. REMOVE TELESCOPE AND MOUNT FROM CARTON. NOTE: THEY COME PRE-ASSEMBLED FROM THE FACTORY.

4. LOOSEN MOUNTING KNOB ON THE TELESCOPE MOUNT (UNDERNEATH)



5. PLACE THE TELESCOPE AND MOUNT ASSEMBLY ONTO THE TOP OF THE TRIPOD.

6. TIGHTEN LOCKING KNOB (UNDERNEATH THE TRIPOD TOP) SECURELY.

7. ATTACH ACCESSORY TRAY

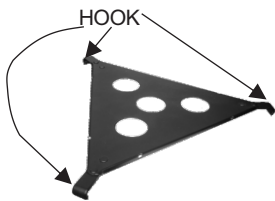

ACCESSORY TRAY

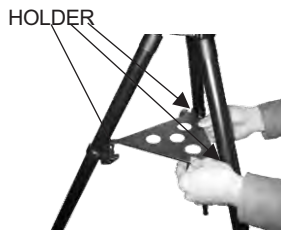

HOLDER

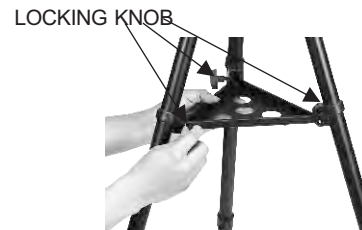

LOCKING KNOB

- (1) SPREAD TRIPOD LEGS APART SO THE TRAY WILL FIT UNDERNEATH
- (2) PLACE THE TRAY'S HOOK OVER THE HOLDER'S METAL ROD AND PUSH DOWN
- (3) TIGHTEN THE HOLDER'S LOCKING KNOB TO HOLD THE ACCESSORY TRAY IN PLACE

8. REMOVE ELECTRONIC MARS-EYE FINDER.

9. USE THE TWO THUMB SCREWS TO POSITION THE ELECTRONIC MARS-EYE FINDER ON THE TELESCOPE TUBE. FOR ADDITIONAL HELP SEE THE PAGE IN YOUR INSTRUCTION BOOK FOR MARS-EYE ELECTRONIC FINDER MOUNTING AND ALIGNMENT.

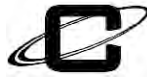

## FEATURES OF C-872EFS



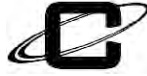

# HOW TO USE EYEPIECES & ACCESSORIES

PLEASE CONSIDER USING YOUR ACCESSORIES IN THE FOLLOWING ORDER. BY DOING THIS YOU WILL BETTER UNDERSTAND THE IMPACT EACH INDIVIDUAL ACCESSORY HAS ON THE FUNCTION OF YOUR TELESCOPE.



CAUTION:  
CLUTCH KNOB MUST BE LOOSE IN ORDER TO FOCUS WITH LEFT FOCUSING KNOB. DO NOT TRY TO FOCUS WITH CLUTCH KNOB TIGHT. (FOR MANUAL FOCUSING ONLY.)

1. FOCUSING TUBE - TURN FOCUSING KNOB (LEFT SIDE) TOWARD THE TELESCOPE UNTIL IT WILL GO NO FURTHER. TO FOCUS MANUALLY BEGIN TO TURN THE FOCUSING KNOB TOWARD YOUR BODY, SLOWLY, UNTIL THE IMAGE IS CLEAR.  
NOTE: YOU MUST HAVE AN EYEPIECE INSERTED IN ORDER TO VIEW IMAGE. RIGHT SIDE IS CLUTCH KNOB



2. DIAGONAL PRISM  
INSERT THE DIAGONAL PRISM INTO THE FOCUSING HOUSING.



TIGHTEN CLUTCH KNOB WHEN USING THE WIRELESS HANDBOX TO FOCUS."

3. EYEPIECE INSERTION -  
AFTER THE DIAGONAL IS INSERTED, PLACE THE EYEPIECE (25MM) INTO THE DIAGONAL PRISM. THE LOWER THE NUMBER ON THE EYEPIECE, THE HIGHER THE POWER YOUR TELESCOPE WILL BE USING. PLUS, YOU DECREASE THE FIELD OF VIEW AND THE BRIGHTNESS OF YOUR IMAGE. WHEN USING EYEPIECES, WE SUGGEST ALWAYS STARTING WITH THE LOWEST POWER AND THEN GOING UP.



4. BARLOW LENS  
THE BARLOW LENS IS USED TO ACHIEVE THE MAXIMUM POWER FROM YOUR TELESCOPE. FIRST, REMOVE THE DIAGONAL PRISM FROM THE FOCUSING TUBE AND INSERT THE BARLOW LENS DIRECTLY INTO THE FOCUSING TUBE. YOU WILL HAVE TO READJUST YOUR FOCUSING DUE TO THE FACT THAT YOU HAVE INCREASED/DECREASED THE POWER OF YOUR TELESCOPE DRAMATICALLY.

EYEPIECE  
25MM  
10MM PLOSSL

POWER  
32X  
80X

POWER W/3X BARLOW  
96X  
240X



## MARS-EYE ELECTRONIC FINDER MOUNTING & ALIGNMENT

### **TO MOUNT:**

- 1) REMOVE MARS-EYE ELECTRONIC FINDER FROM BOX.
- 2) LOOSEN THUMB SCREWS ON SIDE OF FINDER AND SLIDE FINDER ONTO DOVETAIL MOUNT LOCATED AT TOP OF MAIN TELESCOPE TUBE.
- 3) TIGHTEN THUMB SCREWS.

### **TO CHECK ALIGNMENT WITH MAIN TELESCOPE:(IMPORTANT!)**

- 1) THE MARS-EYE ELECTRONIC FINDER IS NOT PRE-SET AT FACTORY. THE FOLLOWING WILL ALLOW YOU TO ADJUST THE ALIGNMENT.
- 2) DURING THE DAY LIGHT HOURS, AIM THE MAIN TELESCOPE AT AN OBJECT AT LEAST 1/4 MILE OR MORE IN THE DISTANCE AND BRING IT INTO FOCUS.(VERY IMPORTANT)
- 3) ONCE YOU HAVE CENTERED THE REFERENCE ITEM IN THE MAIN TUBE, TIGHTEN ALL KNOBS AND ADJUSTMENTS TO PREVENT ANY MOVEMENT.
- 4) REMOVE CIRCULAR BATTERY SAVER LOCATED BENEATH FRONT OF FINDER (BE SURE TO SAVE AND REPLACE THE BATTERY SAVER WHEN NOT IN USE.)
- 5) TURN FINDER ON BY SLIDING ON/OFF SWITCH FORWARD.ON/OFF SWITCH IS LOCATED ON THE RIGHT SIDE OF THE FINDER.
- 6) LOOK THROUGH THE FINDER AND LOCATE THE RED DOT.
- 7) IF THE OBJECT IN THE MARS-EYE FINDER IS NOT THE OBJECT YOU SEE THROUGH THE MAIN TELESCOPE TUBE, ADJUSTMENT IS REQUIRED.
- 8) TO MOVE THE RED DOT UP AND DOWN, SIMPLY TURN THE ELEVATION SCREW LOCATED ON THE REAR BOTTOM OF THE FINDER TO HEIGHT REQUIRED.
- 9) TO MOVE THE RED DOT LEFT AND RIGHT, SIMPLY TURN THE WINDAGE SCREW LOCATED AT THE FRONT LEFT SIDE OF THE FINDER TO THE PROPER POSITION.
- 10) THESE ADJUSTMENTS WILL ALLOW YOU TO POSITION THE RED DOT ON THE SAME OBJECT CENTERED IN THE MAIN TELESCOPE.







# HOW TO USE THE CASSINI IMAGE STABILIZING ELECTRONIC FOCUSER

1. PUT THREE AAA BATTERIES INTO BATTERY HOLDER.

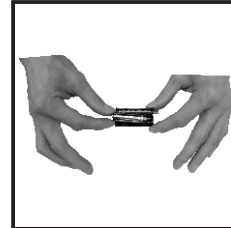

2. INSERT BATTERY HOLDER INTO ELECTRIC FOCUSER COMPARTMENT.

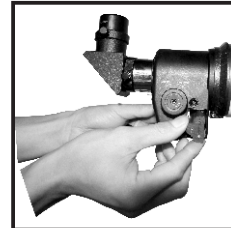

3. CLOSE THE COVER



4. A. TIGHTEN THE RIGHT CLUTCH KNOB TO USE THE FOCUSER ELECTRONICALLY.  
B. LOOSEN THE RIGHT CLUTCH KNOB TO USE THE FOCUSER MANUALLY (LEFT KNOB ONLY).  
VERY IMPORTANT. SEE IMAGE →



5. TURN ON THE ON-OFF SWITCH, THE INDICATOR WILL FLASH ONCE, ELECTRIC FOCUSER IS READY



INDICATOR

ON-OFF

6. WIRELESS CONTROL BOX

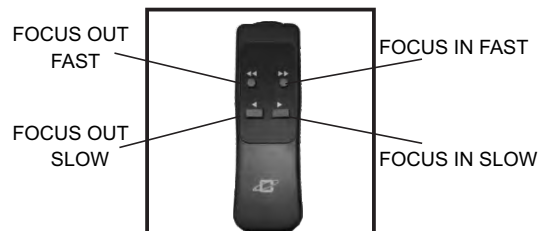



## HOW TO USE THE CASSINI IMAGE STABILIZING ELECTRONIC FOCUSER

7. USE WIRELESS CONTROL BOX TO CONTROL THE ELECTRIC FOCUSER. (MUST AIM TOWARD IR RECEIVER)

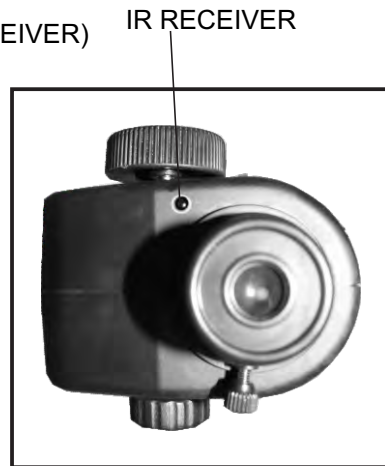

CAUTION: PLEASE REPLACE THE BATTERIES WHEN YOU SEE THE INDICATOR LIGHT OF ELECTRIC FOCUSER FLASHING CONTINUOUSLY, OR WHEN THE FOCUSING BECOMES IRREGULAR.

8. USE THE FAST FOCUS BUTTONS ON THE HANDBOX WHEN THE IMAGE IS NOT CLOSE TO FOCUS, AND USE THE SLOW BUTTONS WHEN YOU ARE CLOSE TO FOCUS AND THE FOCUS NEEDS TO BE FINE TUNED.



## **CASSINI™ Limited One Year Warranty**

We guarantee to replace or, at our option, repair any products or parts thereof which are found defective in material or workmanship during the first year from date of purchase. Our obligation with respect to such products or parts shall be limited to replacement or repair. In no event shall we be liable for consequential or special damages or for transportation, installation, adjustment, or other expenses which may arise in connection with such product or parts. The customer shall be responsible for all costs of transportation and insurance, both to and from CASSINI/COSMO BRANDS INC., and shall be required to prepay such costs. No expenses, warranties and implied warranties, whether or not merchantability of fitness for any particular use or otherwise (except as to title) other than these expressly set forth above which are made in writing and signed by executive officer of our corporation.

**NO LIABILITY FOR CONSEQUENTIAL DAMAGES, IN NO EVENT SHALL THE MANUFACTURER OR ITS SUPPLIERS BE LIABLE FOR ANY DAMAGES WHATSOEVER. BECAUSE SOME STATES DO NOT ALLOW THE EXCLUSION OR LIMITATION OF THE POSSIBILITY FOR CONSEQUENTIAL OR INCIDENTAL DAMAGES, THE ABOVE LIMITATION MAY NOT APPLY TO YOU.**

**CASSINI™  
DIVISION OF COSMO BRANDS INC.  
21230 SW 246th ST. HOMESTEAD FL 33031 USA  
[www.cosmosoptics.com](http://www.cosmosoptics.com)**

**IF YOU NEED ANY FURTHER HELP WITH YOUR CASSINI TELESCOPE  
PLEASE E-MAIL US AT [CUSTOMERSERVICE@COSMOSOPTICS.COM](mailto:CUSTOMERSERVICE@COSMOSOPTICS.COM)**

**CASSINI™  
DIVISION OF COSMO BRANDS INC.  
21230 SW 246th ST. HOMESTEAD FL 33031 USA  
[www.cosmosoptics.com](http://www.cosmosoptics.com)**